

Anna Skurvid

T662KA

Ventilation in sustainable office buildings

Bachelor's thesis
Building Services Engineering

January 2013



MIKKELIN AMMATTIKORKEAKOULU

Mikkeli University of Applied Sciences

DESCRIPTION

 <p>MIKKELIN AMMATTIKORKEAKOULU Mikkeli University of Applied Sciences</p>	Date of the bachelor's thesis 14.01.2013	
Author(s) Anna Skurvid	Degree programme and option Building Services Engineering	
Name of the bachelor's thesis Ventilation in sustainable office buildings		
Abstract <p>In this bachelors thesis I wanted to develop a theme of ventilation system in sustainable office buildings. I discover the term sustainable and find what requirements it has. My thesis consists of two parts. The first one is theoretical part. In this part I write about sustainability of buildings. I use European standards and bring the information about thermal environment from there. I write about categories of buildings and what parameters has each category. Then I collect the ventilation system, which can be suitable for sustainable office buildings. I write about systems, that have certain parameters: energy efficiency, providing good indoor air quality, using minimum resources.</p> <p>In practical part I studied three office buildings. They were constructed and designed in different years. I did there some measurements, which help me to understand the situation with thermal climate in these buildings. I explored, how the ventilation systems changed through years, what developments were used and what else can be done for sustainability of these buildings. I find the building where ventilation system meets all the requirements for sustainable building.</p>		
Subject headings, (keywords) Ventilation systems, Sustainability, Energy Efficiency, Indoor Climate		
Pages 44	Language English	URN
Remarks, notes on appendices		
Tutor Heikki Salomaa	Employer of the bachelor's thesis	

CONTENTS

1 INTRODUCTION.....	1
1.1 General overview	1
1.2 Aims	2
1.3 Methods.....	3
4. INDOOR ENVIRONMENTAL AIR QUALITY	4
4.1 Thermal environment.....	5
4.1.1 Temperature	6
4.1.2 Air velocity	7
4.1.3 Humidity	8
4.1.4 Particles in the indoor air	8
4.2 CO ₂ concentration	11
5 VENTILATION SYSTEMS FOR SUSTAINABLE OFFICE BUILDINGS	16
5.1 Chilled ceilings	16
5.2 Active chilled beam.....	18
5.3 Passive chilled beam	19
5.4 Variable Air Volume (VAV) system	20
5.5 Fan coils	21
5.6 Displacement ventilation	22
5.7 Under floor air distribution	23
5.8 Personal ventilation	24
6 PRACTICAL MEASUREMENTS	26
6.1 Case 1. A-building of University of Applied Sciences in Mikkeli, Finland	27
6.1.1 Construction.....	27
6.1.2 Ventilation system.....	28
6.1.3 Results	29
6.2 Case 2. MIKPOLI- building of University of Applied Sciences in Mikkeli, Finland.....	32
6.2.1 Construction.....	32
6.2.2 Ventilation system.....	33
6.2.3 Results	34
6.3 Case 3. X- building of University of Applied Sciences in Mikkeli, Finland	36
6.3.1 Construction.....	36

6.3.2 Ventilation system..... 37

6.3.3 Results 39

6.4 Comparison of three office rooms..... 42

7 CONCLUSION 42

BIBLIOGRAPHY 45

1 INTRODUCTION

1.1 General overview

As building technology has improved it has become a lot of new buildings. People spend there most part of their life. It is very important to create healthy indoor climate for people's wellbeing and comfort. Human health and sustainability will always be an important factor, whatever people do in the buildings. Good quality of indoor air increases human's productivity. If indoor environment is inappropriate, it can affect people's health. They can feel headache, eye or nose irritation, allergy or thermal stress. Improving the quality of indoor environment increases our wellbeing and health.

“As buildings are producing one third of the greenhouse gas emissions and account for 40% of the used energy it is not possible to prevent climate change without focusing on buildings” /1, p.1/. While being comfortable and healthy they should also not produce excessive environmental load. It is important to focus on sustainability of a building.

Sustainable buildings are the buildings that have good affect on environment and healthy indoor climate. Sustainable buildings save energy and prevent production of pollutants or contaminants. In my bachelors thesis I want to disclose the theme of ventilation in sustainable office building. I think it is very interesting nowadays, when people spend 90% of their lives at work or at home. Comfortable conditions at work place increase productivity. It naturally influences the success of the company.

Another factor of sustainable buildings is using minimum amount of resources (e.g. energy, water). If a building does not need many resources, it means that it will not produce much pollution. This will be not only during construction, but also during the operation. Energy efficiency also concerns heating, ventilation and air-conditioning. Ventilation system in sustainable office buildings has to meet some requirements. First of all it must be energy efficient and does not produce any pollutants or contaminants both in indoor air and outside air.

My bachelor's thesis consists of two parts: theoretical and practical. The first part is theoretical. In this part I discover the requirements for indoor air in offices, based on European standards. I describe such parameters as temperature, air velocity, humidity, indoor air quality. I also consider air filtration and hygiene requirements for ventilation. In the end of theoretical part there are some decisions for ventilation systems for sustainable office buildings.

In the second part of my thesis I do measurement in three office buildings situated in Mikkeli, Finland. They were built in different years. I compare these three cases and see the difference and development of ventilation systems through years. Measurements of thermal conditions, flow rates and carbon dioxide changing are used.

1.2 Aims

The main aim of my bachelor thesis is to develop the theme of ventilation system in sustainable office buildings. I present such literature where relevant information can be found.

After searching appropriate literature, I wanted to know about the thermal conditions in the office room. Which temperatures are more comfortable for productive working, what should be the humidity, air velocity. One more important factor is CO₂ level. It changes through the working day in the room and have a great influence on human health.

Then I consider several ventilation systems that can be used in sustainable office buildings. There are several systems that can not only bring good indoor air quality, but are also energy efficient. It is very important to know their advantages and disadvantages. I describe main features and benefits of each system and find the most appropriate location for them.

The second part of my bachelor's thesis is practical. The main aim in this part is to compare office rooms, which were built in different years. I consider each room separately, see the results of the measurements and then compare with each other. I

measure such things, as temperature, humidity, air flow, air velocity and CO₂ concentration.

1.3 Methods

Methods that I use in my thesis are: literature review and measurements. My thesis divided into two parts: practical and theoretical. In theoretical part I used such method as literature review. I sought books in library in Mikkeli University, in e-library and in internet sources.

Literature search was not so difficult because there some literature about my theme. I use such books, as REHVA Guidebooks – Design of energy efficient ventilation and air conditioning system; HVAC in sustainable office buildings; Indoor climate and productivity in offices, Hygiene requirements for ventilation and air conditioning. I read such European standards as EN 13779:2005 Ventilation for non-residential buildings — Performance requirements for ventilation and room-conditioning systems and EN 15251:2006 Indoor environmental input parameters for design and assessment of energy performance of buildings- addressing indoor air quality, thermal environment, lighting and acoustics. There I find such information as temperature for three several categories (I, II, III). I-category is the best category and has the best conditions for human comfort indoor. III category is minimal requirement for thermal conditions. From these standards I took information about cleanliness of the air and different types of filters.

In my practical part I use measurements. I make measurements in different types of office buildings that were built in several years. These buildings are: A-building, X-building and Mikpoli-building of Mikkeli University of Applied Sciences. I collected the information about these buildings: the year of construction, the type of ventilation system. I choose one room in each building and do there measurement. I used measurement devices from the HVAC laboratory of Mikkeli University of Applied Sciences. I measure temperature, humidity, CO₂ concentration, air flow and velocity in each room. Doing these measurements I compare results with standards. In the end I allocate the best office room with the best conditions. During the measurements I observe how ventilation system principles have changed through years. I also decide

what advantages can bring ventilation system, if these office buildings were sustainable.

4. INDOOR ENVIRONMENTAL AIR QUALITY

When people start to design ventilation and air conditioning systems in the building, firstly they must think about good quality of indoor environment. Good environmental quality can be reached by 4 main characteristics: indoor air quality, thermal environment, acoustic and visual environments. In my thesis I consider two of them: indoor air quality and thermal environment. These parameters have great affect on energy consumption of the building. By controlling them in the right way, good environmental quality can be reached with reducing energy use. /1/

To ensure satisfied workers in office building, at least the following things have to be considered during design. Increased indoor air quality can be reached with high enough ventilation rates. Also air quality becomes better, when air diffusion is good and in balance with furniture layout. Use of demand control ventilation increase energy efficiency, thermal comfort and indoor air quality become better. If there are outdoor impurities, it is important to filter them from the supply air. /2/

It is known, that air quality affects on human health. Outdoor and indoor environment expose people to a multitude of chemical, biological and physical stresses. People spend more than 90% of their time indoors. This time, that they spend indoors, results on their health.

Indoor air contains polluting substances from the outdoor air. Some of them are in fact transferred indoors (e.g. ultrafine particulate) and others are adsorbed on surfaces indoor. Also there are many sources of contaminants indoors. It may be because of the low air exchange rates.

European (EN) and international (ISO) standards provide minimum and maximum air temperature and minimum ventilation rate for occupied spaces. These standards also give the value of maximum concentration of indoor air contaminants which is allowed.

The most common problems of indoor air quality are: ventilation, which is insufficient and poor maintained and failures during the construction period. But these problems can be avoided. Careful design, selection of materials, maintenance and installation are the best solution for these problems. The key factor for achieving good indoor air quality is the ventilation system, but people must not forget about maintenance (e.g. cleanliness) and filtration. /2/

Building materials such as paints and solvents may extract volatile organic compounds (VOC) into the indoor air. New materials typically exhaust more emissions. All this factors show the importance of effective ventilation, especially in new buildings. /2/

The standard, which provides indoor environmental parameters for design of buildings and HVAC systems, is the European Standard EN 15251. This standard uses three comfort category – I, II and III. Category I has the highest level of expectation and recommended for spaces, where really good indoor environment quality is required. Category II has a normal level of expectation and may be used for new buildings and renovations. Category III is a moderate level and should be used for existing buildings. /3/

There are categories in Finland that are very close to this European standard. Finnish Classification of Indoor Climate gives these categories. There are three categories: S1 “individual” (has the same values, that category I of EN15251 has), S2 – “comfortable” (has the same values, that category II of EN15251 has) and S3 – “satisfactory” (the level of National building code of Finland).

4.1 Thermal environment

One of the most important parameters for an enjoyable and healthy building is thermal comfort. The opposite for thermal comfort is thermal discomfort. It may bring illnesses for workers and reduce work. Employees may feel dissatisfaction because of the building. Often the expression thermal conditions is used to characterize the room temperature. But this means not only room temperature. It is a combination of room and surfaces temperature and can be called operative temperature. Temperature has a great influence of the employees in office buildings. /1/

4.1.1 Temperature

Temperature has an influence on office work. you can see this influence on the Figure 1. Low temperatures decrease the work performance, as do the high temperatures. The optimal temperature for office workers is 22°C. People are also satisfied in a range from 20 to 24°C. High indoor temperature has a great influence on the human's body. It can cause such illness, as sick building syndrome. High indoor temperature also increases the level of dryness. Low indoor temperature may increase risk of the draught. Also people are very sensitive to moving of the air when it is cold.

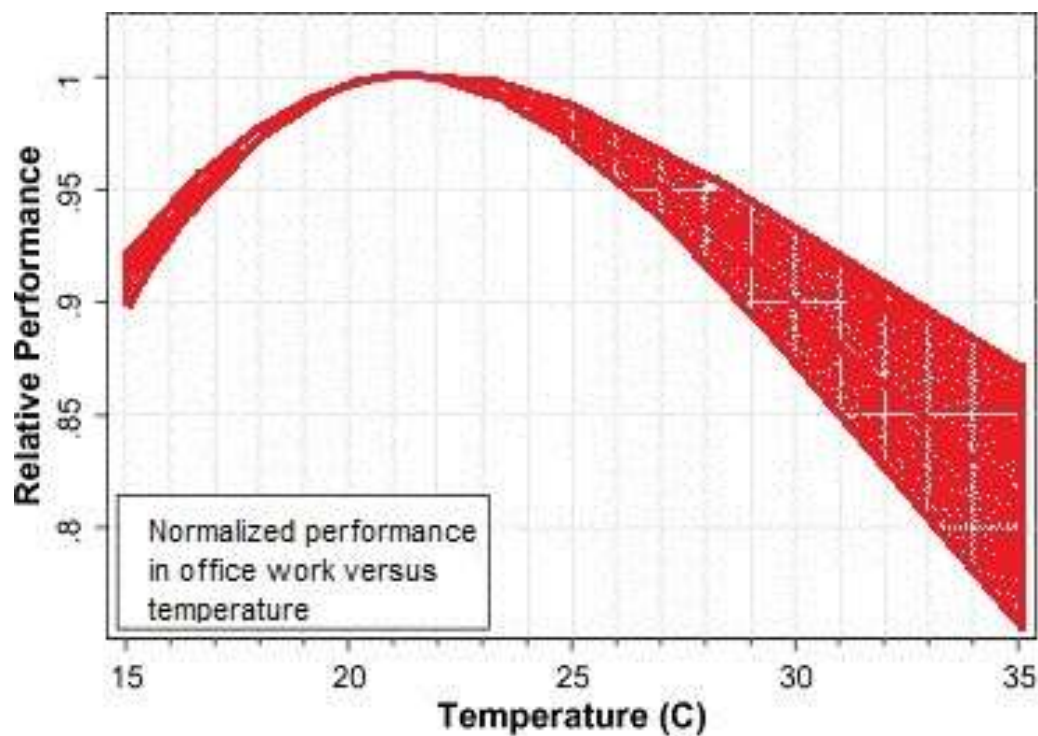

FIGURE 1. The dependence between temperature and relative performance /4/

EN 15251 specifies design values for indoor temperature for heating and cooling periods. These temperatures are given depending on activity type, clothing and comfort category. It is given 1,0 clo for heating period and for cooling – 0,5 clo. The summarized data are shown in the Table 1.

TABLE 1. Temperature ranges for design of buildings and HVAC systems in three categories of indoor environment /3/

Type of building or space	Category	Operative temperature, °C	
		Minimum for heating	Maximum for cooling
Single office; Landscaped office; Conference room; Auditorium*	I	21	25,5
	II	20	26
	III	19	27
*sedentary activities – 1,2 met			

4.1.2 Air velocity

Low temperature and high air velocity may cause draught in the room. People begin to feel draught when the body becomes over-cooled. Draught is a really problem in the buildings and it should be eliminated. It is important to control air diffusion and movement of the air. In Table 2 are shown the values of air velocity. These velocities are given for cooling season (summer) and for heating season (winter). Use of these values help to avoid discomfort.

TABLE 2. Criteria to define draught in office buildings /3/

Type of building/space	Category	Maximum mean air velocity. m/s	
		Summer	Winter
Single office	I	0,18	0,15
	II	0,22	0,18
	III	0,25	0,21

If we think about sustainability the important factor is energy efficiency. Such criteria, as air velocity can be used for reducing energy use. When it is hot high velocity helps human body to feel comfortable. So the need of cooling is reduced. The same situation

is with low temperatures. Less air movement will sustain the body in comfortable condition. Thus, in winter the velocity of air should be the lowest and in summer the highest. Small portative fans can be used to increase the air velocity in summer period.

4.1.3 Humidity

One important factor for human comfort in office is the value of relative humidity. However, dehumidification and humidification do not play a great role in human health. People feel themselves comfortable in a huge range of relative humidity. There are some values for humidity in EN 15251. In Table 3 design criteria for the relative humidity in occupied spaces is recommended. These values can be used if humidification or dehumidification systems are set by human occupancy. These values are given in a such way that can save the energy.

TABLE 3. Humidity values in occupied spaces if humidification or dehumidification systems are installed /3/

Category	Design relative humidity for dehumidification, %	Design relative humidity for humidification, %
I	50	30
II	60	25
III	70	20

Using the values below the limits of dehumidification or above the humidification can increase the use of energy. However, where terminal units based on water, then the relative humidity level need to be at that level at which condensation does not appear. Typically, the maximum on which set the relative humidity is 55%. /2/

4.1.4 Particles in the indoor air

The indoor quality can be measured by the quantity of small particles that suspend in the air. They can cause serious problems with health. Particles come both from outdoor and indoor air. Small particles originate outdoors and large (diameter of 1

micron) – indoors. The source of small particles is mainly combustion (production of power, heating, electricity). The ventilation and air conditioning systems must have filters to protect the indoor air from these outdoor particles. Of course filtering uses energy. It means that it should be selected carefully.

Sometimes people do not care about the filtration. The importance of this system is really great. It protects the ventilation system and equipment, save ventilation devices and occupants from contaminants.

EN determines low polluting buildings and very low polluting buildings. Low polluting building is a building, where the majority of the materials are low polluting. Very low polluting building is a building, where all of the materials are very low polluting (stone, glass and metals) and smoking is not allowed. The comparison of emissions limits are shown in Table 4.

TABLE 4. Values of emissions of impurities from materials /3/

Impurity	Low polluting building	Very low polluting building
The emission of total volatile organic compounds (TVOC)	< 0.2 mg/m ² h	< 0.1 mg/m ² h
The emission of formaldehyde	<0.05 mg/m ² h	<0.02 mg/m ² h
The emission of ammonia	<0.03 mg/m ² h	<0.01 mg/m ² h
The emission of carcinogenic compounds (IARC)	<0.005 mg/m ² h	<0.002 mg/m ² h

Ventilation is needed to provide good air quality and of course clean air for people to breath. For healthy life, a person needs 10 l/s of clean air. EN 15251 defines minimum ventilation rate to assure good dilution of emissions, which is presented in Table 5.

TABLE 5. Ventilation rate for different building types /3/

Building type Category	Very low polluting building	Low polluting building	Non low-polluting building
Category I	0,5 l/s, m ²	1,0 l/s, m ²	2,0 l/s, m ²
Category II	0,35 l/s, m ²	0,7 l/s, m ²	1,4 l/s, m ²
Category III	0,3 l/s, m ²	0,4 l/s, m ²	0,8 l/s, m ²

The large variation of ventilation rates can be explained by different density of the occupants. When only the selection of interior material is important, then it can be seen further dependence. The ventilation rate can be reduced by 30-40%, when low pollutant materials are used, and by 50-60% when using very low polluting materials. This has a great influence on ventilation energy consumption.

The European standard EN 13779 defines filter performance, which is required in a ventilation system to get good Indoor Air Quality (IAQ). This requirement takes into consideration the outdoor air. There three category of outdoor air, which EN 13779 suggests: ODA 1, ODA 2 and ODA 3. ODA 1 is the best air quality, in which air is pure except for temporarily dusty (e.g. pollen). In ODA 2 category outdoor air is with high concentration of pollutants and in ODA 3 the concentration of gaseous pollutants and/or particulate is very high. Gaseous pollutants are the concentrations of Carbon monoxide (CO), Carbon dioxide (CO₂), Carbon dioxide (SO₂), Nitrogen dioxide (NO₂) and Volatile organic compounds (VOCs).

After the categorizing of outdoor air quality, EN 13779 gives the classes of filters, to achieve selected Indoor Air Quality from IDA 1 (high IAQ) to IDA 4 (low IAQ). These classes of filters are shown in Table 6.

TABLE 6. Dependence of the outdoor air quality and the targeted indoor air quality on filter class /5/

Outdoor Air Quality	Indoor Air Quality			
	IDA 1 (High)	IDA 2 (Medium)	IDA 3 (Moderate)	IDA 4 (Low)
ODA 1	F9	F8	F7	F5
ODA 2	F7, F9	F6, F8	F5, F7	F5, F6
ODA 3	F7, GF, F9	F7, GF, F9	F5, F7	F5, F6
GF = Gas filter/Chemical filter				

There are recommendations of typical ranges for sound pressure levels depending on building type and type of space.

- Office rooms: design value – 30 dB(A);
- Meeting rooms: design value – 35 dB(A);
- Landscaped offices: design value – 40 dB(A). /3/

4.2 CO₂ concentration

Significant reduction of air exchange can provide adequate energy saving of ventilation systems. Naturally, the reduction of air exchange should not cause any reduction in the level of comfort in the room.

There are two ways to determine the required air exchange rate - based on the specific norms of air exchange and on calculation basis of permissible concentrations of pollutants.

In the first case, the required air quality is achieved by supplying a certain amount of outside air in the space, depending on the purpose of the room and its mode of operation. In the second - the required air quality is achieved by supplying a certain

amount of outside air in the space, depending on the size and characteristics of pollutants in the room.

The use of the second method, which is based on the balance of hazards in a ventilated volume, is physically justified and allows to determine the value of necessary air exchange taking into account outdoor air pollution and the level of comfort in the room. Its use in public buildings is difficult, since the composition and size to the room of harmful substances is often uncertain. In practice, both methods or there combination are used.

Amount of carbon dioxide exhaled by a person depends on the type of his activities. I have found different meaning of this value. For example in a handbook of district heating and ventilation /6/ this value is 23 l/h, National Spirometric Association in USA tells about 27 l/h and various sources from the internet tells that it is 24l/h. I collected this data and decided to take mean value 24 l/h.

European standard EN 13779, is now a national standard in all EU-members countries, establishes four categories of indoor air quality from IDA 1 - high quality to IDA 4 - poor quality.

Table 8 shows the excess of carbon dioxide in the occupied zone relative to outdoor air for various categories of air quality.

TABLE 8. Indoor air quality classification /6/

Category	Description	CO ₂ -level above level of outdoor air in ppm	
		Typical range	Default value
IDA 1, (I)	High indoor air quality	<400	350
IDA 2, (II)	Medium indoor air quality	400–600	500
IDA 3, (III)	Moderate indoor air quality	600–1 000	800
IDA 4, (IV)	Low indoor air quality	>1 000	1 200

The same standard provides data of the concentration of carbon dioxide in the atmosphere, which is:

- in rural areas without significant sources of pollution - 350 ppm;
- in small towns - 400 ppm;
- in city centers - 450 ppm.

The influence of carbon dioxide on the health and status of people investigated in a number of works. Maximum permissible concentration of carbon dioxide can be taken both from analysis and from the modern European standards.

O.V. Eliseeva made a detailed study on the justification of maximum permissible concentration of CO₂ in the air in residential and public buildings. By using a special method of research, the author concluded that short-term inhalation of healthy people the carbon dioxide concentration of 500 and 1000 ppm causes distinct changes in lung function, blood circulation and electrical activity in the brain. Obtained data allowed to conclude that the concentration of CO₂ in the air of residential and public buildings should not exceed 1000 ppm. /7, pp. 36-38/

Researches, which were carried out in Taiwan /8/, established that number of markers which have the negative changes in the DNA growing under the influence of volatile organic compounds and carbon dioxide at levels above 800 ppm in the body of the office staff. Number of markers is directly connected with the time of staying in the room.

Modern research /8/ indicates that because of the level of CO₂ above 800 ppm staff in office buildings had symptoms of "sick building syndrome" (SBS): irritation, dry cough, headache, decreased performance, inflammation of the eyes, nasal congestion, nasal inflammation, problems with the respiratory system, a dry cough, headache, fatigue and difficulty concentrating. A number of researchers believe that carbon dioxide is one of the main causes of SBS.

Measurements in offices in Moscow have shown that in a number of offices carbon dioxide concentration is reached 2000 ppm and above /8, pp 19-35/. The problem of high carbon dioxide concentration in the offices exists in EU, USA, Canada and many other countries.

Table. 9 shows the CO₂ limit values included in the standards of some leading countries.

TABLE 9. Limit values of carbon dioxide in the occupied zone /9, pp. 5-14/

Country	Standard	CO ₂ level
Finland	Finnish Classification of Indoor Environment 2008 /10/	Air Quality (ppm): High - 700 Average - 900 Satisfactory. - 1200
USA	Standards ASHRAE 62-1989 «Ventilation for normal Air Quality »	1000 ppm
UK	Building Bulletin 101 Ventilation of School Buildings 2006	1 500 ppm - the marginal rate for the school day from 9:00 to 15:30
Holland	Hygienic standards "Overview of air quality standards for kindergarten in Holland"	1000 ppm - hygienic standards for kindergarten 1200 ppm - hygienic standards for schools

As it is seen from table 3, the concentrations of CO₂ in the room in the EEC countries and the U.S. are close to each other, mainly 600-1 000 ppm.

It is known that in rooms Category I, ventilation with untreated outdoor air, with high and low pollution, is problematic. Solution to the situation is to use absorbers of carbon dioxide from the outside or recirculation air.

Absorber of carbon dioxide is a tape, which is placed in a metal case. In case there is two or more cassettes. While one cassette store CO₂, removing it from the air, the other (s) is recovered. That allows to support set parameters of the level of CO₂ continuously. Amount of sorbent material is calculated according to defined conditions. The lower the concentration of carbon dioxide, which is necessary to maintain in the room, the more absorbent is required. Absorbers of carbon dioxide are working according to a program and do not require frequent maintenance. Service

includes a change of the pre-filter. The frequency change depends on the quality of air that comes into them. Usually, it is 6-9 months. Cassette with an absorbent in normal use, need to be replaced in 10-15 years (this period depends on the operating conditions). Therefore, labor costs on service of absorbers of CO₂ are minimal.

Setting of absorbers in supply ventilation allows to reduce the concentration of carbon dioxide in the room to specifications. There are also absorbers of carbon dioxide, which can work without installation in ventilation systems. Absorbers can be placed both on the outdoor and on the recirculated air. Fig. 2 shows a possible layout of the absorber to the recirculated air.

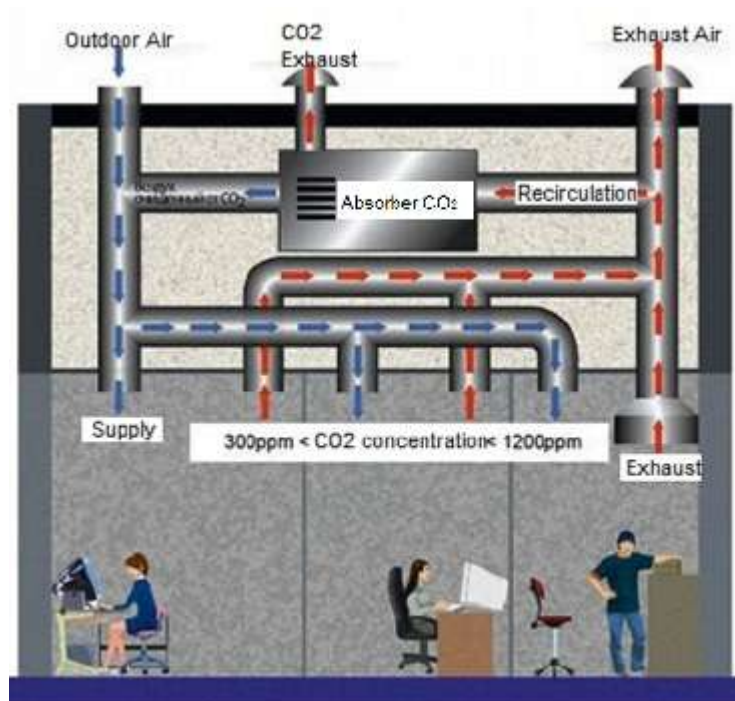

FIGURE 2. Example of installation absorber of carbon dioxide in indoor air recirculation /9, p. 10/

In Fig. 3 you can see an illustration of absorber effectiveness. The graph demonstrates the concentration of carbon dioxide in the room during the use of the absorber.

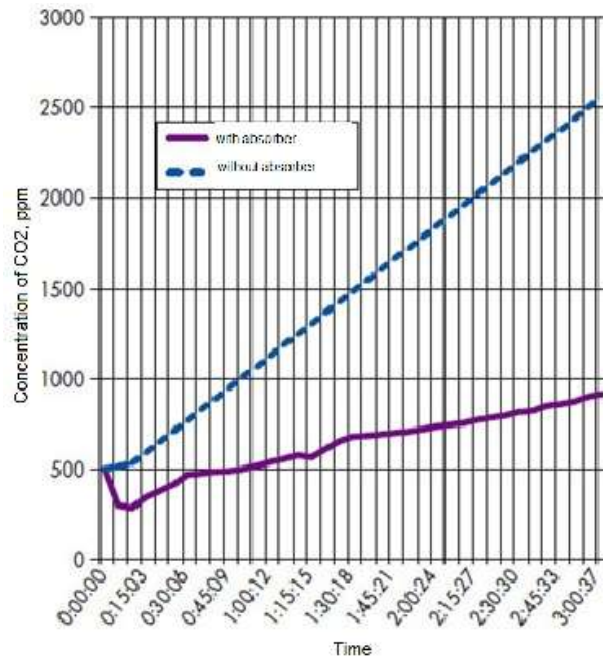

FIGURE 3. Change in the concentration of CO₂ in the room /9, p.11/

The use of such devices could bring cleaner and healthier air in the workplace.

5 VENTILATION SYSTEMS FOR SUSTAINABLE OFFICE BUILDINGS

As I have mentioned above, sustainable buildings are buildings that use minimum energy, have good indoor quality and also do not pollute the environment. Ventilation systems in such buildings have to meet some requirements. The indoor air must be pure, temperature, humidity and air velocity must be at the appropriate level. Nowadays people want to take care of their health. The solution to these is to moderate the system of the buildings, e.g. ventilation system. There are some of the latest technical solutions for ventilation system that can help to improve indoor environment quality. One more important fact for these systems is energy efficiency. In this chapter I mention some of these systems.

5.1 Chilled ceilings

Chilled ceilings are special devices for providing radiant and convective cooling to the space below. They are fixed to the ceilings. Each unit consists of pipes in a serpentine pattern. These pipes transfer water. Water temperatures for cooling are 14-18°C and for heating – 30-40°C. There are two variants of installation. The first one is when

pipe is attached to the metallic panel and this construction is mounted to the ceiling. And the second variant is, when pipe is integrated as a suspended ceiling solution, as you can see on Figure 4.



FIGURE 4. Chilled ceiling installation /11/

Also there are models of chilled ceilings with integrated material that absorbs sound. Standard cooling output of this system is $\sim 50-70 \text{ W/m}^2$. Chilled ceiling installation is well suited for sustainable office buildings because of the following benefits. It is not needed to have large ceiling void, 60-70 mm is enough. This system does not demand extra maintenance. In addition to this chilled ceiling installation creates good indoor climate, because it provide quite and draught-free affect. Also it save energy, as a temperature of chilled water is not high. /2/

The risk of condensation can be considered as a disadvantage of this system. To avoid this problem the room temperature must be controlled. This system is not very fast and has slow reaction. Chilled ceiling required a separate ventilation system.

Chilled ceilings can be used in combination with other systems. For example, ceiling diffusers are well suited to work with chilled ceilings. Also displacement and personal ventilation can find place in combination with chilled ceilings. /2/

5.2 Active chilled beam

This system is used for cooling, heating and ventilating spaces. The active chilled beam system is joined with chilled water system and with ventilation supply air duct. The primary air flows from the main air handling unit into the rooms through the chilled beam. The heat exchanger is situated in the chilled beam. Room air flows into this heat exchanger and circulates there. At the same time water is circulated through heat exchanger. It can be cold for cooling (14-20°C) or warm for heating (30-40°C). Air from the room and the primary supply air are mixed and then they are distributed to the space. The temperature in the room can be changed by variation the water flow rate. Schematic illustration of this system is presented on Figure 6. Standard cooling output of this system is $\sim 50-120 \text{ W/m}^2$. /2/

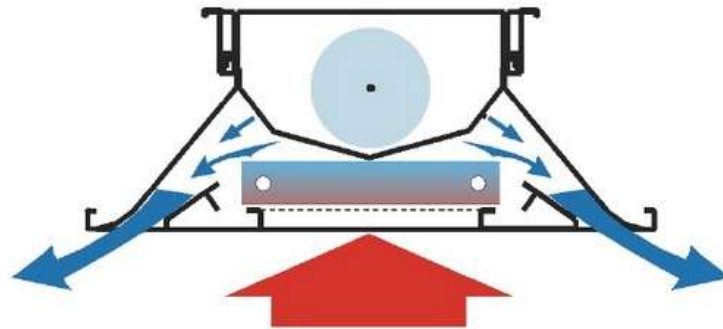

FIGURE 6. Active chilled beam /11/

The benefits for using this system in sustainable office buildings are the following. First of all it can provide silent operation without draught. Then the need of ceiling void depth is relatively small. One of the most important factor for sustainability of a building is energy saving. In this system it operates because of no need for very hot temperatures or very cold. One more benefit of this system that it can be prefabricated with the integrate lighting, acoustic system and so on. /13/

There also some disadvantages of this system. One of the main is risk of condensation. To avoid the appearance of condensation water temperature must be controlled according to indoor air conditions. Another disadvantage is the cost of this system. It is expensive. The operation of chilled beam is not very fast. It takes some time to regulate the conditions on a appropriate level.

Active chilled beam system can be used with ground source heat pumps, which also can work in a combination with passive chilled beams. About the system of passive chilled beams you can read further.

5.3 Passive chilled beam

The passive chilled beam system operating under the influence of natural convection and with a minor part of radiation. As an active chilled beam, passive chilled beam has a heat exchanger. Room air rises up, goes through heat exchanger and then moves down into the room. This process is presented in Figure 7.

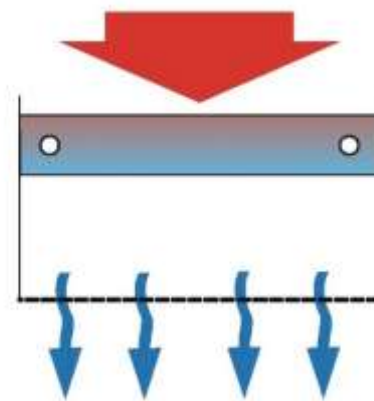

FIGURE 7. The operation principle of passive chilled beam /11/

Passive chilled beam are not connected to the supply air ductwork. There can be separate diffusers located on the ceiling. Passive chilled beams are connected to the water that is cycled through it. It can be cold water (14-18°C) for cooling. Room temperature can be controlled regulating the water flow that flows through heat exchanger. Standard cooling output of this system is $\sim 40-120 \text{ W/m}^2$ /13/. Looking for plusses and minuses of this system, I have found that they are very close to the plusses and minuses of active chilled beam, accept for one limitation of passive chilled beam. In this system is independent ventilation system is needed. /2/

Halton, Swegon and Flaktwoods are the main companies in Scandinavia, which produce chilled beams. They have different models but operational principal is the same. The biggest variety of models has Halton Company. This company produces adaptable active chilled beams, active chilled beams, multi-service chilled beams, swirl comfort units and passive chilled beams. Flatwoods company produce two different models for passive chilled beams and four models for active chilled beams.

Swegon company has the smallest number of chilled beams models: Adriatic, Pacific and FRB. All these models have differences in pressure range, cooling and heating capacity, primary airflow and of course sizes.

5.4 Variable Air Volume (VAV) system

Ventilation systems with variable air volume are working in change mode of the supply air. Variations in load space are compensated by changing the volume of supply and exhaust air at its constant temperature, coming from the central supply installation.

VAV ventilation system reacts to changes in the heat load of individual rooms or areas of the building and modifies the actual amount of air, which is supplied to the room or area. Due to this, a total flow rate of air is less than required at a total maximum heat load of the individual rooms. This reduces consumption of energy and save a given quality of indoor air. Reduction energy costs can be 25% or more compared with ventilation systems with a constant flow of air. /11/

VAV ventilation system designed so that it can be quickly adapted to the new conditions of operation in the case of modernization or reconstruction of the building. This also applies to the control system. The components of variable air volume system is shown on Figure 8.

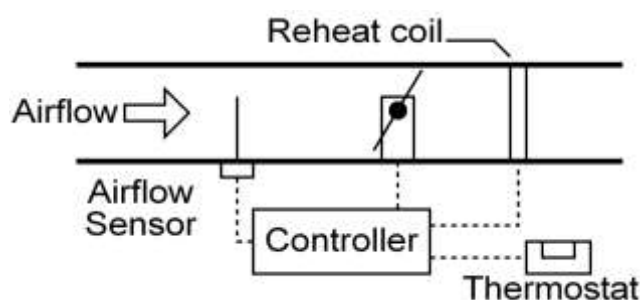

FIGURE 8. The operation principle of variable air volume system /11/

This system has some advantages. VAV allows to regulate the air parameters individually in different areas. That can bring more comfortable thermal conditions for workers in office building. This system can be regulated by CO₂ sensor, motion sensor, time relay and also by manual regulators for changing the air flow. VAV system gives the ability to control the total air flow in the air handling unit. /11/

An example of variable air flow is demand control ventilation. Demand controlled ventilation is based on controlling and changing of air flow rate. It is based on indoor temperature, air quality or/and CO₂ concentration. Demand controlled ventilation consists of units, which control air flow rate, diffusers and sensors of temperature, indoor air quality and occupancy sensors. This kind of ventilation can be used in large auditoriums, meeting rooms where can be large amount of people. In this situation the change of air flow rate will be helpful and will bring good air quality in right place and in right time.

Every office building tends to have large rooms for meetings and conferences. But it is no need to heat, cool or dehumidify these places with no reason, when there are no people. Demand control ventilation save energy by avoiding the using of more ventilation air than it is required. This kind of ventilation makes the indoor air quality at high level, because of using the indoor air quality sensors. It is very convenient to use this system with active chilled beams or passive chilled beams, also displacement ventilation can be used in combination with demand control ventilation. /11/

Demand controlled ventilation has some disadvantages. First of all this system is not cheap and need maintenance of the sensors. Special diffusers should be used in this system, because the risk of drought may occur.

5.5 Fan coils

Fan coil is a device that can be installed in different rooms. Its main function is to regulate the temperature. Fan coils, typically consist of a heat exchanger with fan, filter, control panel. On request they can be supplemented with accessories. The principle of the fan coil unit is as follows. Air in the room, enters the heat exchanger fan coil. Air gets the proper temperature there - cooled or heated. The operation principle is presented on Figure 9. The advantage of fan coil units is that fresh air can flow into it from both central air conditioner or from the supply installation. This also helps to solve the problem of ventilation in the room, when installing with the chillers and fan coil units.

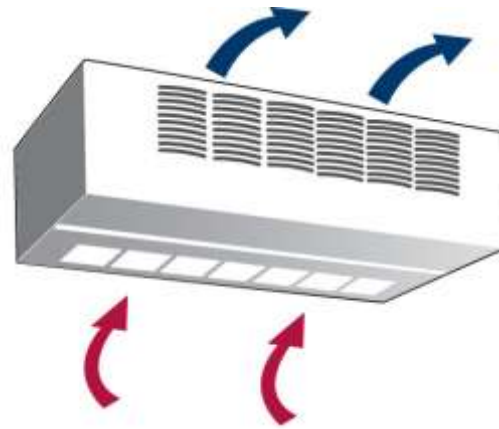

FIGURE 9. The operation principle of fan coil /11/

The system chiller-fan coil can have different configurations, depending on the size of the room. One chiller can be connected with many fan coils. Total thermal level of the system can be controlled by remote control. This remote control can also change modes for each fan coil separately. There are two types of remote controls: the first one can be mounted outside the system and the second is mounted directly on the fan coil. Fan coils are classified according to the power, size, design, a control method and appearance. /11/

5.6 Displacement ventilation

Process of displacement ventilation is not very complicated. The cool air is supplied at floor level and then by means of convection flows upward. Upward air movement occurs by internal heat sources, such as equipment and people. The warm air is collected above the occupied zone, where mechanical exhaust unit is situated or by natural means. Displacement ventilation has some requirements. First of all, cool air must be supplied with low velocities, to avoid draught, as ventilation units are located in the occupied zone. Also the supply air cannot be lower than 18°C, otherwise occupants may feel discomfort. The best results for this kind of ventilation can be achieved in spaces higher than 3,5m, like atriums or lobbies. Standard cooling output of this system is ~30-40 W/m². /2/

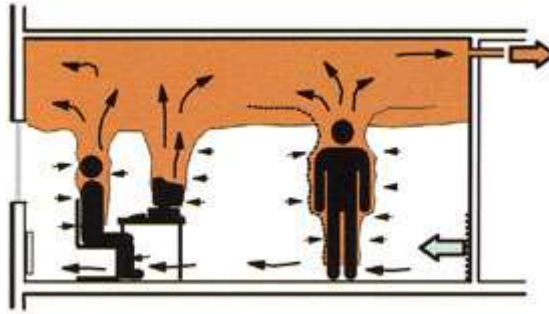

FIGURE 10. Under floor air distribution /2/

Displacement ventilation needs to be used in large spaces as demand control ventilation. For both systems energy efficiency is one of reasons to use them in sustainable office buildings. In displacement ventilation energy saving occurs because of using less air by achieving good air quality and thermal comfort. Also this system is insensitive to loads deviation and for this reason the work of this system is the same in all loads cases.

There are some limitations concerning displacement ventilation. It can be used only in spaces with 3,5 m or more ceiling high. Ventilation devices can take much space. The risk of drought may appear near terminal units. Separate heating system is needed when displacement ventilation is used.

5.7 Under floor air distribution

Air floor distribution system is a ventilation system that distributes air to the room through diffusers in the floor. The main aim of this system is to maintain comfort and good indoor quality only in the occupied zone. Under floor air distribution and displacement ventilation are more and more popular alternatives to the traditional “fully-mixed” systems. Those systems try to get in one condition all space. Under floor systems give unique chances for energy savings, improve air quality indoors and control the comfort. /14, pp.21-24/. The example of under flow air distribution is presented on Figure 11.

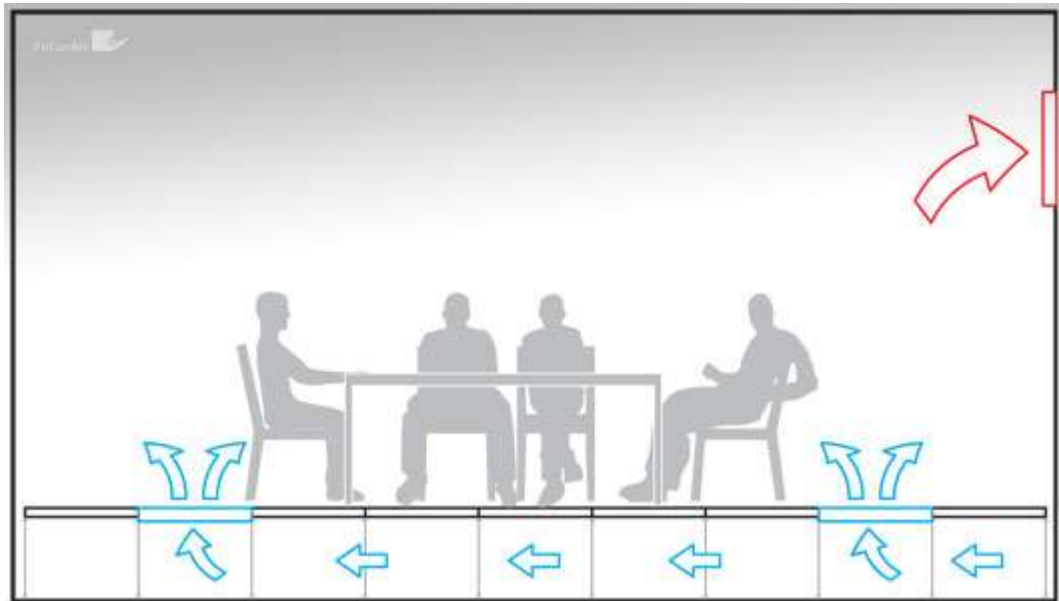

FIGURE 11. Under floor air distribution /14, pp. 22/

Besides the advantages of this system, there are also some disadvantages. It is not also good, when cold air can be near the occupants. So the supply outlets must be located not near the zone where the person spend most of the time. It can be a possibility of draught also. Extra space is needed for this system, because it is located under the floor. There are some tightness requirements. /2/

Under floor air distribution can be used in combination with chilled ceilings and passive chilled beam. Also personal ventilation can be used with this system. The solution when under floor air distribution is combined with another energy efficient system gives advantages for buildings to be sustainable.

5.8 Personal ventilation

Personal ventilation is some kind of micro system that provides supply air directly to a place of work. This system is located very close to the person, near the breathing zone and works faster than air conditioning. Personal ventilation system consists of modules on the desk or on the wall, which provide fresh air to the occupant. Due to them person get sufficient air quality. Also personal ventilation can have an occupancy sensor, which feels presence of the occupant and stop working, when no one is on the workstation. /2/ An example of device for personal ventilation is presented on Figure 12.



FIGURE 12. Air diffuser for personal ventilation /12/

The main purpose to this system is to improve thermal environment on the certain place. In some cases the occupant can control the air jet by himself, according to his own feeling. It is very useful, because all people are different and with this kind of system they can find the solution, when they will feel comfortable conditions. This system is suit for sustainable office building, because it has such advantages as reducing the risk of airborne contaminants to be exposed, improving air quality in the breathing zone, reducing total air flow rate.

All these ventilation systems can take place in sustainable office buildings. They have different principals of working, but they have one general aim. These ventilation systems help people to feel comfortable at their workplaces during the day. It means that the productivity of workers tends to be on a high level. Another important aspect of choosing these systems in sustainable buildings is energy efficiency. Their benefit is a possibility of controlling the system. They can bring not only good indoor quality and comfortable thermal conditions, but also energy savings.

To achieve category I in EN 15251 several ventilation systems can be installed. This category present requirement that can be achieved individually, according to people feelings. Chilled beams, fan coils, variable air volume system and personal ventilation can be installed to get the necessary requirements. There is a control panel in this system, so people can control the indoor climate individually.

6 PRACTICAL MEASUREMENTS

In my bachelors thesis I decided to compare the ventilation systems in three office rooms which are located in three different buildings and were built in different years. There are some requirements for this types of buildings, that I have mentioned above. I used European standards EN 15251:2006 and EN 13779:2005 to compare the requirements from them with the measurements. It is very important if office building meet these requirements, because of a human health. People spend a lot of time at work. Most of the office workers have sedentary work and have no possibility to breathe outdoor air. The main aim of ventilation system in office building is to make comfortable conditions and provide good air quality.

Many factors can influence on indoor climate: air temperature, air humidity, air velocity, CO₂ concentration and how much new air is flows in room every second. In each building I have chosen one office room. In each room I did the same measurements in order to have a possibility to compare the function of each ventilation system. It was very interesting to see the results, because these three buildings were constructed in different years, so the ventilations systems too. To see the development of ventilation systems was also one of my goals.

As all measurements were the same in each room, firstly I want to describe the process of measurement and then to explain the situation in each building and the results.

I measured such parameters as changing of air temperature, humidity and CO₂ concentration through the day and measured air flow rate and air velocity once. For measuring temperature and relative humidity I used data loggers (Ebro). These devises are very comfortable for using, they are quit small and can measure temperatures form -30°C to +60°C and relative humidity from 0 to 100% rH. The accuracy of data loggers is +/-0,5°C. This device has huge memory and a lot of measurements can be done with it. It can be programmed for various programs. I did measurement every 3 minutes and my measurement lasted 3 days for every office room. Also I measured CO₂ concentration by means of TSI instruments HP12 3RT. The range of this device is 0 – 5000 ppm. Air velocity and air flow rate were measured by SwemaAir 300. SwemaAir 300 can measure air velocity, air flow, air humidity and temperature. The

accuracy of this device is $\pm 3\%$. The velocity of air was measured at the level of 1,1 m, it is the neck level of sedentary person. I have measured the noise level also. The name of this measuring device is Brüel & Kjær. This device is easy in use, has 5 different languages and can give the average value. All measurements were done in autumn and I considered it as heating period. The results were compared with parameters, which I considered above for office buildings.

6.1 Case 1. A-building of University of Applied Sciences in Mikkeli, Finland

6.1.1 Construction

This building was taken in use in 1996. The main constructing material is brick. A-building is a part of buildings complex of Mikkeli University of Applied Sciences. The picture of this building you can see on Figure 13. It is divided into 2 floors. On the first floor situated small café, one big auditorium for conferences, several classrooms for students and laboratory. The measured office space is located on the second floor, where such offices and several rooms are located.



FIGURE 13. A-building of University of Applied Sciences in Mikkeli, Finland

6.1.2 Ventilation system

The office room, in which I have measured, has an area of 20 m². It has one big window and three persons are working there. It is a large room in comparison with others, but it is not very comfortable for three persons to sit there. There are three computers and one printer. As it is a working process there a lot of documents and papers all over there. This room has a mechanical ventilation system. This mechanical ventilation is equipped by a heat recovery unit. The type of this unit is rotating wheel. According to design value supply air flow rate for this building should be 5310 dm³/s and exhaust air flow rate - 4800 dm³/s.

In the office room there are two diffusers for supply air and one diffuser for exhaust air. There is a radiator under the window. This radiator is used for heating and has a thermostat, which is used for controlling the indoor temperature. The working day lasts somewhere about 8 hours. People, who are sitting there, are teachers and they do not spend all of their working time in the office room. They are going to the lessons and then go back to the office room. The photo of this office room is presented on Figure 14.



FIGURE 14. Office room in A-building

6.1.3 Results

Temperature and humidity

Temperature and humidity rates were measured in this room. The measuring devices were installed from 9th of October till 12th of October. The measuring lasted 3 days for this office room. Outside temperature in those days was 5-7°C, humidity 78%. The results are presented on Figure 15. This graph demonstrates the change of temperature and relative humidity through the three working days. It is not hard to notice that the peak of the temperature is 21,8°C and the lowest temperature is 20,3°C early in the morning. When people come to work the temperature starts to rise, then reaches peak and after working time begin to fall. The dependence can be explained in a following way. For energy saving the ventilation system starts to work at 7 am and ends at 7 pm, maintaining the set temperature. The mean temperature value during working hours is 21,5°C and it meets the requirements of temperatures in office room.

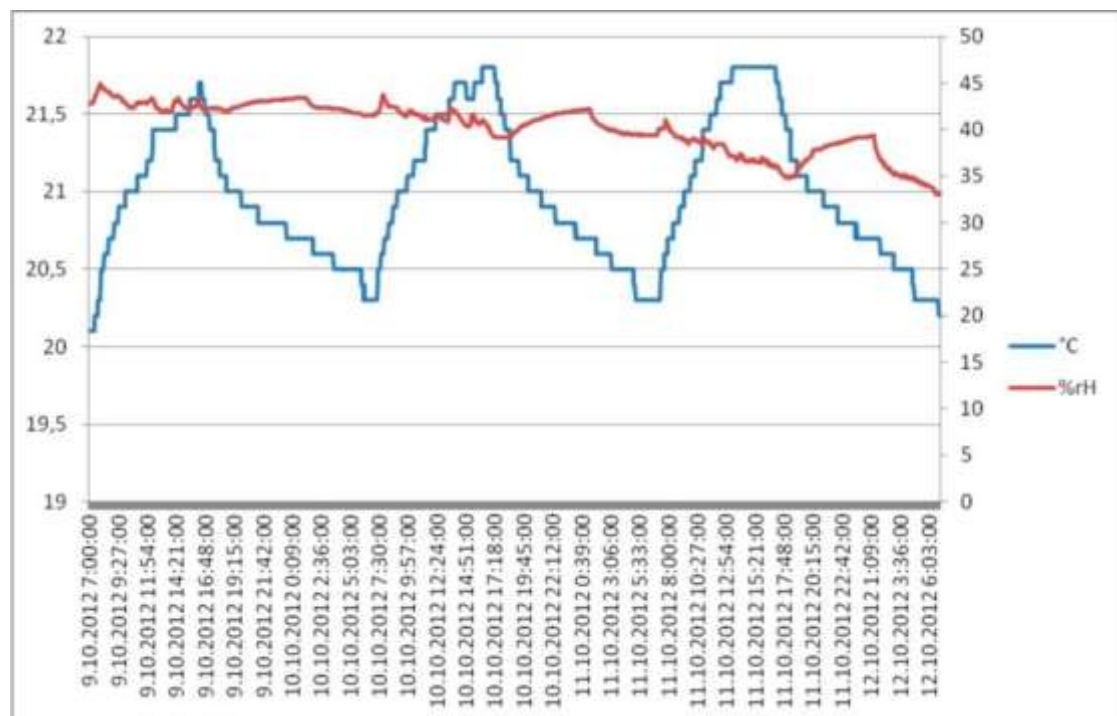

FIGURE 15. The change of temperature and relative humidity in office room in A-building

The situation with relative humidity is almost stable. It changes from 33% to 45%, which also meet the requirements. The value of relative humidity has small changes at

the end of the working day. It can be related with cleaning of the office room. Everyday the value of relative humidity increases slightly and then slightly goes down.

CO₂ concentration

One more important factor that was measured is CO₂ concentration. The results are presented on Figure 16. The measurements were done from 14th of October till 16th of October. The dependence can be seen on the diagram. This building is located in small town where the concentration of carbon dioxide in the atmosphere is near 400 ppm. I started my measurements of CO₂ level on the 14th of October, it was Sunday. I wanted to see the value of CO₂ in the empty office. The measurements demonstrate the value of 400 ppm. It is the same result that I expected to see. When people comes to work the concentration of CO₂ increased and reached the peak of 700 ppm. As it is said in EN 13779 this office room meets the requirements for CO₂ concentration.

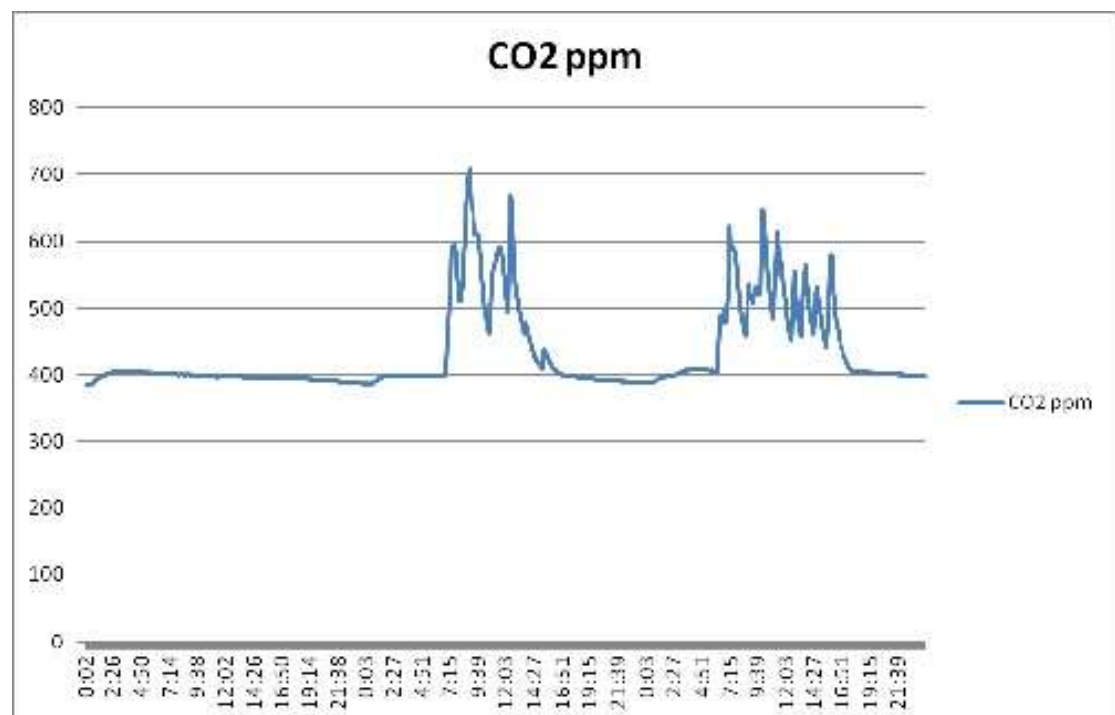

FIGURE 16. The change of CO₂ concentration in office room in A-building

Temperature, relative humidity and CO₂ concentration meet the requirements of the I category for office buildings.

Air flow rate, velocity and noise level

This office room has two supply diffusers and one exhaust diffuser. From one supply diffuser the air flow rate is 10,2 dm³/s and from another 10,1 dm³/s. So it can be identified that supply air flow rate to this room is 20,3 dm³/s. The exhaust air flow rate is 18,6 dm³/s. Ventilation system in Finland is designed according to National Building code D2. There the following values are described. These values are presented in Table 10. The rate of volume flow is dependent on the area of the room. This office room in A-building has an area of 20 m². According to D2 the supply air flow rate must be 30 dm³/s. The value that I measured is not very close to requirement. It must be at least 10 dm³/s more. If we consider that there are three person in the room at the same time, so for one person will be 6,7 dm³/s air flow. This value is more than the limit of 6 dm³/s but less then it is required (10 dm³/s). This room will be suitable for to person only.

TABLE 10. Requirement for office buildings according to D2. /16/

Space type	Outdoor air flow (dm ³ /s) per person	Outdoor air flow (dm ³ /s)/m ²	Extract air flow (dm ³ /s)/m ²	Sound level L _{A,eq,T} / L _{A,max} dB	Air velocity (winter / summer) m/s	Note!
Offices and similar rooms		1,5		33 / 38 *	0.20 / 0.30	*C1 guidel.
Conference room	8	4		33 / 38	0.20 / 0.30	#3
Customer area		2		38 / 43	0.30 / 0.40	#2,
Corridor area		0.5		38 / 43	0.30	#2,
Canteen, break area		5		38 / 43	0.25	
Archive, storage room			0.35			

The measurement of air velocity was the following. I measured the velocity near the workplace on the high 1,1m. This is the high of the most sensitive part of human body – neck. The measured velocity is 0,16 m/s. It is less then maximum air velocity even for the I-category in office building. It can be concluded that this value meet all the requirements /3/. Air moving does not influence on the thermal comfort of the occupants.

I measured the noise level in this office room. The measured value was 42 dB(A). This value is a little bigger than the requirement gives, it may be because of switch on computers. /3/.

Obtained data corresponds to S2 class of Finnish Indoor Climate classification.

Interview

I have asked the occupants how they feel themselves in this office room. They do not feel any problems with indoor air quality in the room. The temperature and humidity are on the good level. They feel themselves comfortable. There no problems with headaches and another illnesses because of the indoor climate. The low level of eair flow rate does not effect on their well-being. May it is because of the fact that they are do not spend all the time in the office room. There are rarely 3 people in the room at one time.

6.2 Case 2. MIKPOLI- building of University of Applied Sciences in Mikkeli, Finland

6.2.1 Construction

Mikpoli building of University of Applied Sciences was taken in use in 2008. It is a large building which consists on three parts: A, B and C. Office rooms, lecture halls, café are situated there. It consists of three floors. On the 3rd floor conference room, sauna and big balcony are situated. The picture of this building you can see on Figure 17. This building has modern ventilation system. There is displacement ventilation in the lecture hall and chilled beams are used in the corridors and in the office rooms.



FIGURE 17. Mikpoli-building of University of Applied Sciences in Mikkeli, Finland

The room, where measurements were done is located on the first floor. It is office room for two persons. The area of this room is 12 m². The occupants do not spend all working time in this room. There are two big desks, computers and a lot of documents in this room.

6.2.2 Ventilation system

This room has modern ventilation system. The photo of this room is shown on Figure 18. One big chilled beam is located on the ceiling. Exhaust diffuser is situated on the ceiling near the door. This room is equipped with control panel, so the occupants are able to make the temperature in the room higher or lower. One big window is situated in this office room. It is really huge and takes place from floor to ceiling. There is one convector under the window. It has a thermostat, so occupants can regulate the heat load from convector.

There a heat recovery in air handling unit in this building. The type of heat recovery is rotating wheel. Heating coil, cooling coil, filters are located in that air handling unit (AHU). AHU is located on the upper part of the building. There are also intake chamber for outdoor air. Filters restricting air flow and preheating are located there. Supply air flow rate for this building is designed to be 4,1 m³/s.



FIGURE 18. Office room in Mikpoli-building

6.2.3 Results

Temperature and humidity

Measurements were made from 21st of November till 23rd of November. Outdoor temperature in that days was +6...8°C and humidity 87-100%. Temperature and relative humidity were measured with data logger (Ebro). I started the measurements at 3 pm 21.11.2012 and ended at 12 am 23.11.2012. This time were enough to see the change of temperature and relative humidity. The minimum value of temperature in this office room is 22,1°C. This value was at 10 pm in the evening, when nobody was in the room. The maximum value of the temperature is 22,9°C. This value was in the middle of the working day, at 12 am. As it is seen from the Figure 19, temperature has not got a large variation through the day and night. Change occurs within one degree of Celsius. It can be explained by several facts: occupants does not spend in the room all working time, computers and light are not switched on during the day, ventilation system on the high level and air change rate is high. The variation of relative humidity is also not big. It changes from 26 to 35 %rH.

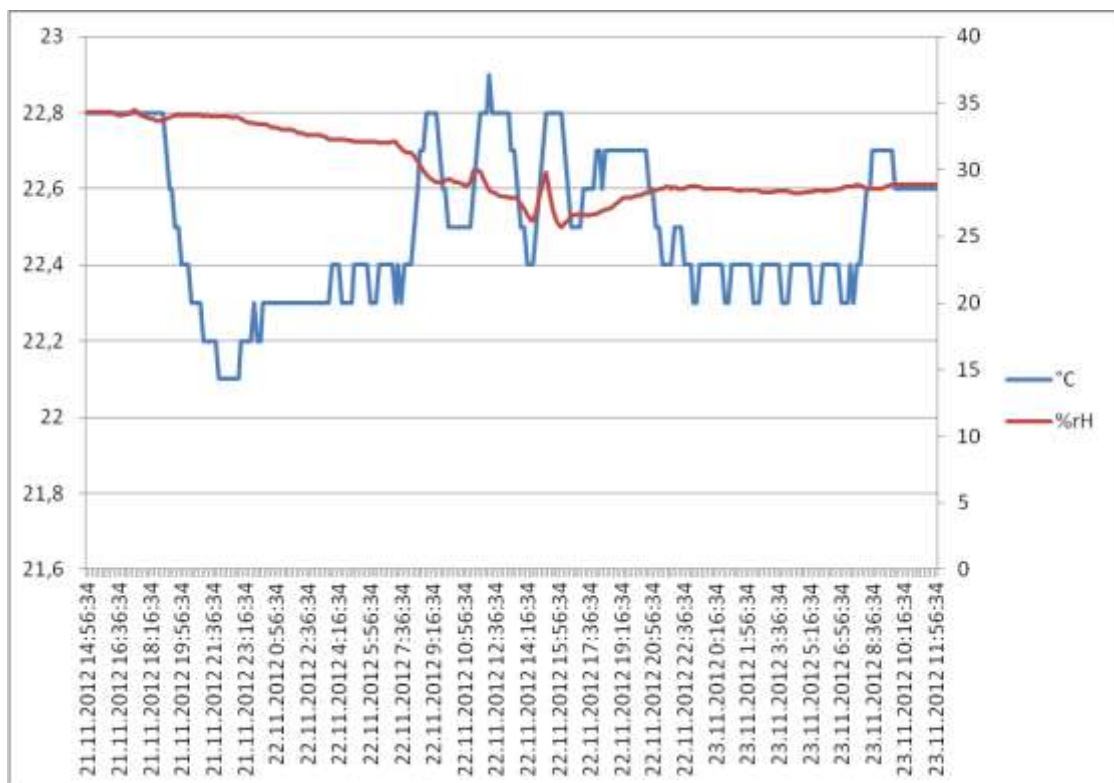

FIGURE 19. The change of temperature and relative humidity in office room in Mikpoli-building

On the Figure 19 the dependence between temperature and relative humidity can be seen. When the temperature rises, the relative humidity decreases.

CO₂ concentration

I did the measurements of CO₂ concentration in this room for 3 days: from 21st of November till 13rd of November. The results are presented on Figure 20. As you can see from the graph on Figure 17 the change of CO₂ through the day is not very big. There is only one peak on 750 ppm at 3 pm on 22nd of November. Not big variation of CO₂ indicates that people do not spend much time in the office room or the ventilation air change rate is really high. If it is so, than the peak of 750 ppm can be explained by the quantity of people in the room at 3 pm, e.g. there were not only two occupants, but three or more. The level of CO₂ does not exceed the maximum range of 1200 ppm. It means that this office room meets the requirements.

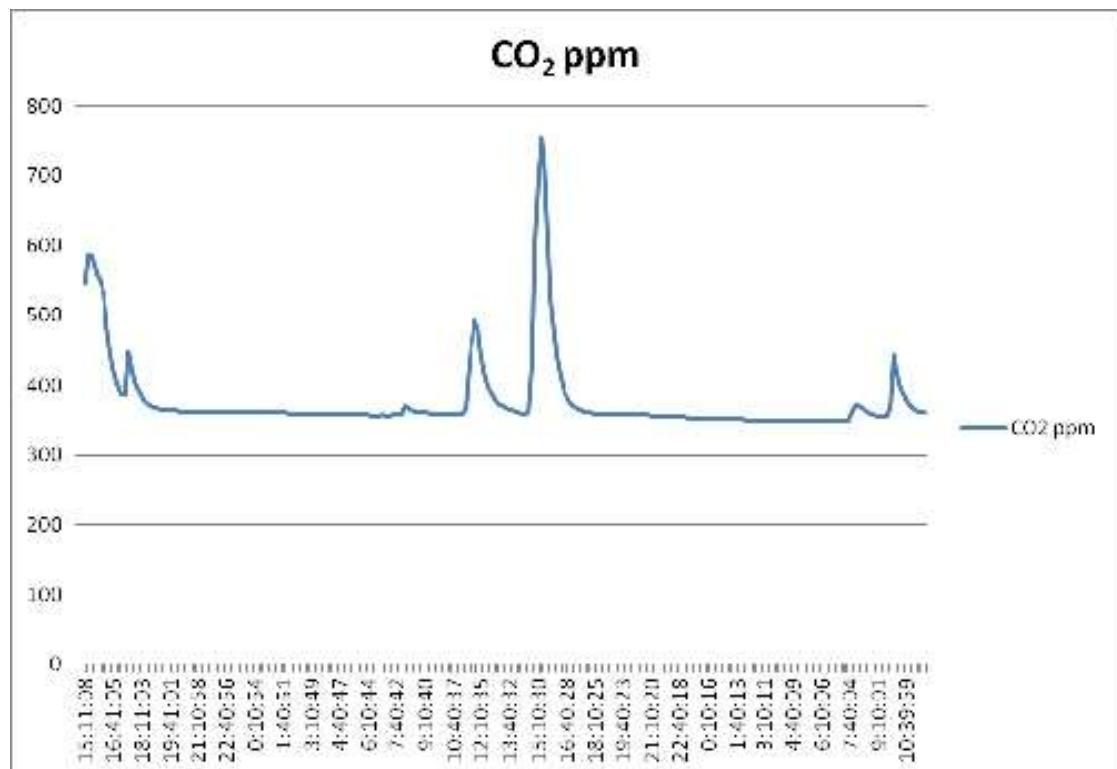

FIGURE 20. The change of CO₂ concentration in office room in Mikpoli-building

Air flow rate, velocity and noise level

I measured air flow of exhaust diffuser on the ceiling once. The measured value was 16 dm³/s. If we consider, that for one person 8 dm³/s is enough, then the air flow in the room meets the requirements of Finnish Classification of Indoor Environment /10/.

This value corresponds to S2 class of Indoor Climate Classification. But if we think about the sustainability of the office room and take into account the EN 15251 where minimum value for one person is $10 \text{ dm}^3/\text{s}$, then the ventilation system of this room does not meet the requirements. There is also one more important factor. Temperature and humidity levels are on the appropriate levels and people feel themselves comfortable on the working place when they are sitting in the room. But they do not spend there a lot of time. So this room can be considered as sustainable because of the indoor climate.

Air velocity is not high. Measured value was $0,18 \text{ m/s}$ on the high of $1,1 \text{ m}$. With such temperature and velocity the appearance of drought is impossible. Noise level was also measured in this room. The measured value was 38 dB(A) . For landscaped offices: design value – $40 \text{ dB(A)}/3$, it also corresponds to D2.

Interview

I have asked people who are working in this room about their indoor climate feelings. They answered, that they are satisfied with the work of ventilation system. Temperature and humidity level on the high level for them, they do not even control the temperature from the control panel, only sometimes. They do not feel any drought.

6.3 Case 3. X- building of University of Applied Sciences in Mikkeli, Finland

6.3.1 Construction

This building was taken in use in 2011. The building materials are concrete, metal, some walls are made of glass. This building is younger than the previous one. It has three floors. The room where the measurements were done is located on the 1st floor. There are a lot of small office rooms located on the 1st floor. The photo of this building is presented on the Figure 21.



FIGURE 21. X-building of University of Applied Sciences in Mikkeli, Finland

The office room has an area 15 m^2 . It is small office room with two big windows. This room is intended for two people. They are working in international office and do not spend all of their working time in the office room. Sometimes students come into the room for consultations and it can be four people in the room for one time. There are two tables and two computers.

6.3.2 Ventilation system

Ventilation system of this office room is as modern as the previous one. The part of this room is presented on Figure 22. On the ceiling there are two active chilled beams. Two exhaust diffusers are located near the door. The operation of active chilled beam was described in part 3.3. In this room the model CBC Halton is used. This unit combines cooling, heating and supply air. It is good solution especially for office rooms, because high quality of environmental conditions is needed in such places. This device also can save the energy, because low water flow rates are used. There are two radiators in the room equipped with thermostats. They are used for heating and with the help of thermostats occupants can control the temperature in the room.



FIGURE 22. Office room in X-building

The control panel is situated in this room near the door. Thermal conditions can be controlled using this control panel. Occupants can control the room temperature by changing the position of the cursor on the control panel. The exhaust diffusers and control panel are shown on Figure 23.



FIGURE 23. Office room in X-building

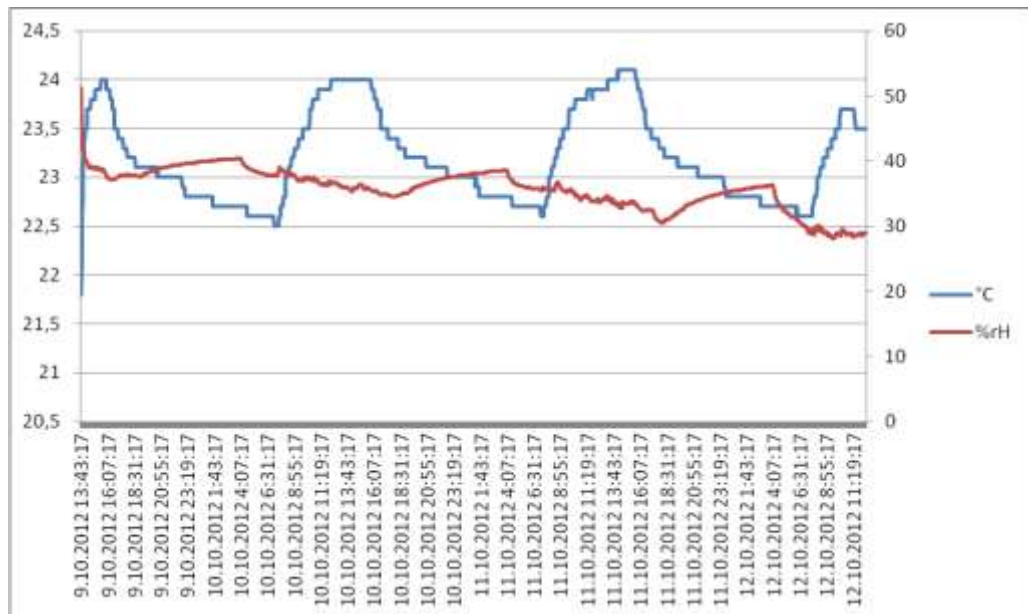

FIGURE 25. The change of temperature and relative humidity in office room in X-building

Relative humidity is also illustrated in Figure 25. The range for this value is between 28% and 40%. These values correspond to EN 15251. Office workers in this room are feeling satisfied with temperature and do not feel discomfort related to humidity. The temperature can be controlled by control panel. Occupants can regulate it depending on their feelings. In this room temperature a little bit higher than in A-building on 1-2°C. It can be lower, but workers who are sitting there, want it on that level. They said they feel themselves comfortable with such temperatures. It is very good that they can control the temperature otherwise they otherwise they would not feel very comfortable, because of low temperature.

CO₂ concentration

The concentration of CO₂ in this office room is presented on Figure 26. The measuring period was from 9th of October till 12th. For this period some dependence can be identified. The minimum value for CO₂ concentration is near 400 ppm. This value can be found only when nobody is presented in the room. The peak value is near 700 ppm and it is 300 ppm more than at night. As you can see from the Figure 17 the variation of CO₂ concentration is not stable. It can be because of the fact that the occupants do not spend all the time in the office room. This sudden changes show it in

a right way. There are some peaks also. It means that two or more people were presented in the room for a short time period.

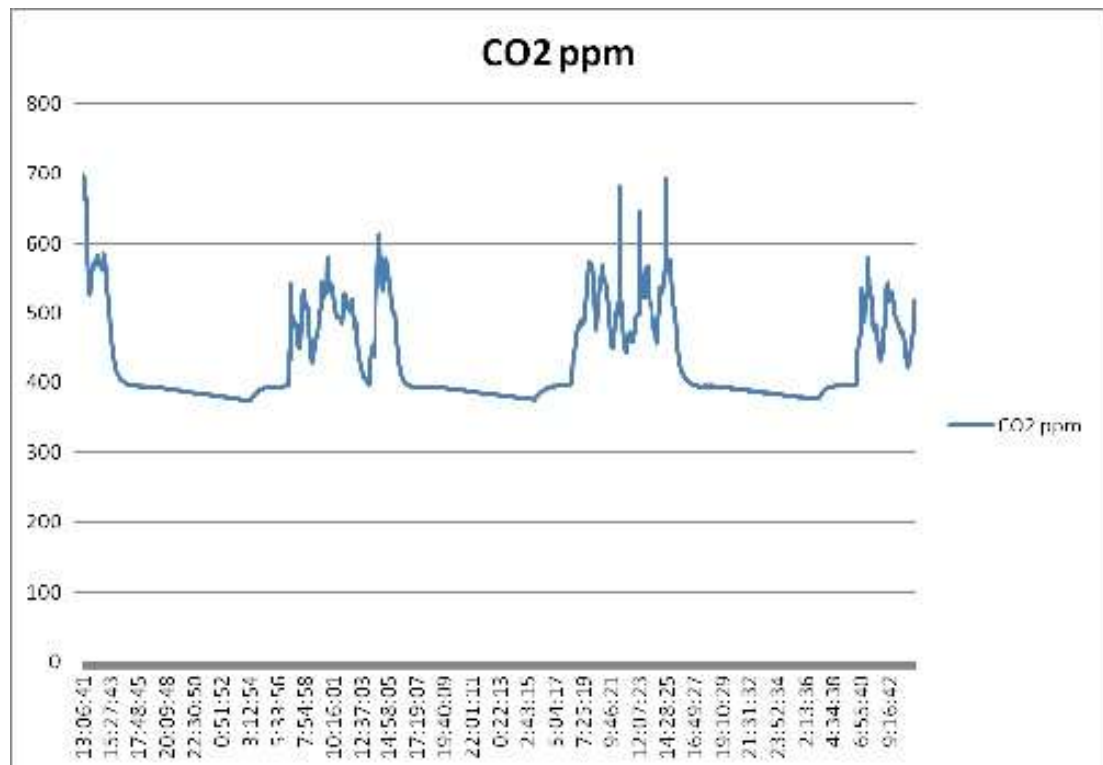

FIGURE 26. The change of CO₂ concentration in office room in X-building

Air flow rate, velocity and noise level

The supply air flow rate to the office room is 30 dm³/s and exhaust - 30 dm³/s. These values meet the requirements for the I category of office buildings.

Air velocity measurements were done on the 9th of October at 13.45. Air velocity was measured on high 1,1 m near the office desk. The measuring device indicates the air velocity 0,18 m/s. This value corresponds to Category II EN 15251 and meets the requirements. So no draught can be detected in this office room.

I measured the noise level in this room. measured value was 46 dB(A). It is a little bit bigger, then said the requirements. /3/

Interview

I have asked workers of this room about their feelings concerning indoor air quality. They said that that they are satisfied with the temperature and humidity. In this case

slight rise in temperature is explained by personal feelings of the occupants. They use the control panel and always put the temperature on high level. They do not feel draught and satisfied with the indoor climate in the room.

6.4 Comparison of three office rooms

It is often easier to see the values in the table way. So I collected all results in one table and compare is with European Standards. The results are shown in Table 10.

TABLE 10. Comparison of three buildings

	EN 15251 EN 13779	A-building	M-building	X-building
Year of taken in use		1996	2008	2011
Type of ventilation system		Mechanical Supply and Exhaust	Mechanical Supply and Exhaust	Mechanical Supply and Exhaust
Temperature, °C	Minimum 21,0	20,3 – 21,7	22,1 – 22,9	22,5 – 24,1
Relative Humidity, %rH	30-60	33 – 45	28 – 40	26 – 35
Maximum CO ₂ level, ppm	1200	700	750	700
Air flow, dm ³ /s, person	10	6,3	8	15
Air velocity, m/s	0,15	0,16	0, 18	0, 18
Noise level, dB(A)	30-40	42	38	36

7 CONCLUSION

In my bachelors thesis I wanted to describe the theme of ventilation system in sustainable office building. My main aim was to uncover the notion of sustainability. I wanted to know the values of thermal environment that will satisfy the office workers and also use not much energy. the term sustainability refers not only the ventilation system. It refers to the construction of the building, lighting, heating, air conditioning and to all systems that use energy. The main purposes of sustainability is saving

energy, making comfort conditions for indoor climate and extracting less pollutants in the outdoor air.

My thesis is divided into two parts: theoretical and practical. First of all I described the requirements for ventilation system, which are used in sustainable buildings. I wrote the limit values for temperature, relative humidity, CO₂ concentration, air flow, air velocity and noise levels. After setting the requirements need to think about the equipment which can make such conditions in the rooms. Nowadays there are a lot of ventilation systems, but not all of them suits to the sustainable office building. They must not only give the appropriate levels of indoor climate, but also save the energy. Energy saving can be done by regulating air flow, air and water temperature and the operation time. I described the ventilation systems that meet those requirements.

The best conditions in the room can be achieved if person regulate the temperature by him self. The I category of EN 15251 and ICC tells that it is “individually” category. It means that thermal conditions must be regulated according to people feelings. In my thesis I described the ventilation system that can be controlled individually. This factor not only provide the nessesary conditions in the office room, but also save the energy. Saving the energy occurs because of the fact that people regulate the thermal conditions depending on their feelings. Special sensors can be installed in the room: CO₂ sensor, motion sensor, time relay. These sensors react to the situation in the room and change the air flow rate if it is needed. It was interesting to know how special features help the office workers to feel comfortable in the room and with what thermal conditions they feel satisfied.

The second part of my thesis was practical part. I did the measurements in three different office rooms in different buildings. They were built in different years. And I wanted to see if the ventilation in these rooms meet the requirements of sustainable buildings. Two of these rooms (in M-building and in X-building) have the ventilation system as for sustainable building. There mechanical ventilation with active chilled beams. Indoor climate in all office rooms satisfy the needs of workers. Difference from A-building (which has only supply and exhaust diffusers) is in the ability to control the supply temperature as the workers need. This possibility allowed saving the energy. All examined buildings has air handling units with heat recovery. The type of heat recovery is rotating wheel.

The situation in all office rooms on high level. Occupants do not complain on indoor climate. But if we think about sustainability, then ventilation system in X-building is most deserving of this title. It has appropriate ventilation system that not only save energy but also make comfortable indoor climate.

X-building was taken in use in 2011. It has modern ventilation system. The main thing that makes the ventilation system sustainable is individual control by means of active chilled beams. it helps for productivity of office workers by setting the thermal parameters individually. the obtained values meet the requirement of category II of EN 15251 and S2 class of Indoor Climate Classification. it might be the I category, but the temperature level is higher, than accepted. This level is controlled by workers by themselves.

When people start to design ventilation and air conditioning systems in the building, firstly they must think about good quality of indoor environment. The standards give the target values for indoor climate and special ventilation systems help to provide this values to the room.

BIBLIOGRAPHY

1. Nejc Brelih, Olli Seppanen. REHVA Guidebook: Design of energy efficient ventilation and air-conditioning systems. Romania. 2012.
2. Virta Maija, Frank Hovorka. REHVA Guidebook: HVAC in Sustainable Office Buildings - A bridge between owners and engineers. Romania.2012.
3. European standard EN 15251:2006. Indoor environmental input parameters for design and assessment of energy performance of buildings- addressing indoor air quality, thermal environment, lighting and acoustics.
4. Which temperature is best for your productivity? WWW document. www.productivity-Sciences.com Last updated 08.2008. Referred 04.11.2012.
5. European standard EN 13779:2005. Ventilation for non-residential buildings — Performance requirements for ventilation and room-conditioning systems.
6. Щекин Р.В., Корневский С.М. Справочник по теплоснабжению и вентиляции. Будивельник. Киев 1976.
7. Елисеева О. В. К обоснованию ПДК двуокиси углерода в воздухе. Гигиена и санитария. 2004, 8. Pp. 36-38.
8. Clements-Croome DJ. Work performance, productivity and indoor air. SJWEN Suppl. 2008, 4. Pp. 19-35
9. Губернский Ю. Д., Шилькрот Е. О. Сколько воздуха нужно человеку для комфорта?. АВОК. 2008, 4. Pp. 5-14.
10. Classification of Indoor Environment 2008. Target Values, Design Guidance and Product Requirements. Finnish Society of Indoor Air Quality and Climate. Pdf file. FiSIAQ publication 5. Trinklet Oy. Helsinki. 2010.
11. Asif Syed. Advanced building technologies for sustainability. John Wiley & Sons, Inc., Hoboken, New Jersey. 2012.
12. Chilled Beam Design Guide. Halton Oy 2007.
13. Virta Maija. REHVA Guide Book: Chilled Beam Application. Romania. 2004.
14. Allan Daly, P.E. Under floor air distribution: lessons learned. ASHRAE Journal. No.5. Pp. 21-24. 2002.
15. ASHRAE 62–1989. Ventilation for Acceptable Indoor Air Quality.
16. D2 National building code of Finland. Indoor climate and ventilation of buildings. Helsinki, Finland. Ministry of the Environment on the indoor Climate and ventilation of buildings. 2002.